

OPERATING INSTRUCTIONS & SERVICE MANUAL

SOLID-STATE BASIC AMPLIFIER

SANSUI BA-90



Sansui[®]

SANSUI ELECTRIC COMPANY LIMITED

Welcome to the group of proud owners of the SANSUI BA-90, a solid state stereophonic basic amplifier from the manufacturer of some of the world's finest audio components. Both in appearance and performance, the BA-90 is professional throughout. Not a single detail has been overlooked in designing and manufacturing the BA-90 for optimum performance. It has been subjected to not only numerous electrical and mechanical measurements, but repeated listening tests as well. The end result is an advanced basic amplifier with a music power output of 90 watts, ideal for use in an electronic crossover system for the truest high fidelity sound reproduction ever.

It is now up to you to read the instructions contained in this booklet to fully enjoy all the advanced performance capabilities built into the BA-90.

CONTENTS

OPERATING INSTRUCTIONS

SWITCHES AND CONTROLS	3, 4
CONNECTIONS	5, 6
ELECTRONIC CROSSOVER SYSTEM	7, 8
HINTS ON USE.....	9, 10, 11
SPECIFICATIONS/CHARACTERISTICS.....	12

SERVICE MANUAL

SCHEMATIC DIAGRAM.....	13, 14
TROUBLESHOOTING CHART	15, 16
ALIGNMENT	17, 18
PRINTED CIRCUIT SHEETS AND PARTS LIST.....	19, 20, 21, 22, 23, 24
OTHER PARTS AND THEIR POSITION ON CHASSIS	25, 26



SWITCHES AND CONTROLS

Power Indicator

When power is turned on, the lamp lights up to indicate the amplifier is in operation.

Aural Null Balance Switch

Use to balance the sound volumes from the right and left speakers. To balance, first set both LEVEL ADJUST controls at "5", then turn the volume control(s) on your pre-amplifier (or tuner-pre-amplifier) to a position which gives you the desired sound volume. Set this switch in the TEST position. Then set the pre-amplifier's (or tuner-pre-amplifier's) mode switch in MONO and set its balance control at its center position. Finally, adjust either the right or left LEVEL ADJUST control so that little or no sound is heard from both speakers. Once this achieved, the sound volumes from both speakers are well balanced. Next, set the AURAL NULL BALANCE switch back in its NORMAL position and the pre-amplifier's (tuner-pre-amplifier's) mode switch back in its STEREO position, and you're ready to enjoy perfect stereo sound.

NOTE: If you set the AURAL NULL BALANCE switch in the TEST position with your pre-amplifier's (or tuner-pre-amplifier's) mode switch left in the STEREO position, the difference between the two stereo channel signals will be heard from the speakers. So be sure to feed monophonic signals into the BA-90 when attempting to balance the stereo channels.

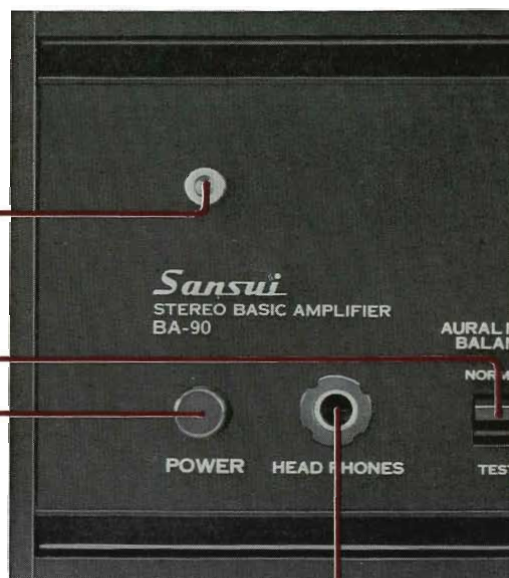

Headphones Jack

Insert the plug of a stereo headphone set into this jack for private listening. Though any type of headphone set with a plug which matches this jack can be used, a dynamic type stereo headphone set is recommended.

Power Switch

Turns power supply on and off. Push it once to turn on, and push it again to turn off.

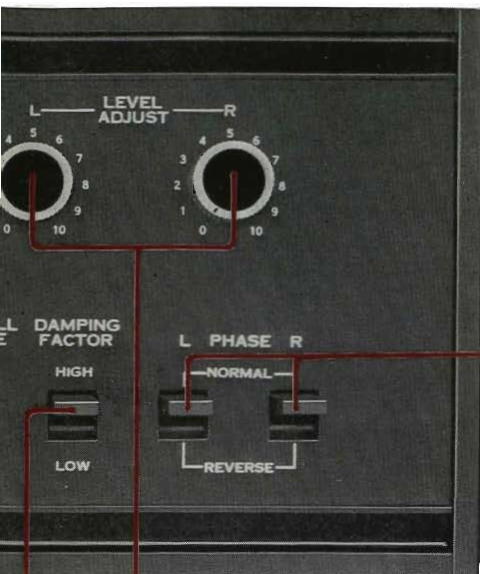

Level Adjust Controls

Use to control the sound volumes from the speakers. Turn them clockwise to increase volume, and counterclockwise to reduce it. The left control adjusts the sound volume from the left speaker, and the right control the sound volume from the right speaker.

Damping Factor Switch

Allows you to change the amplifier's damping factor between HIGH and LOW to suit the speakers in use or your personal taste. HIGH gives you a damping factor in excess of 50 at 8 ohms load, and LOW a damping factor of 10 at the same load. Select the one that gives you the best sound reproduction.

Phase Switches

Since the right and left speakers produce sound waves, it is necessary for them to be driven in the same direction (phase) for a true stereo effect. Should one of the speakers be connected out of phase with the other, sound of certain frequencies will be cancelled out. If you sit in the center of two speakers so connected and listen to a monophonic record, you will notice a lack of sound in the center and weakened bass response.

If you have already connected the speakers and find this is the case, change the phase of either speaker simply by switch the corresponding right or left PHASE switch from NORMAL to REVERSE or REVERSE to NORMAL. Once the two speakers are in phase with each other (i.e., once the polarity connections of the two speakers are matched), they will sound as if there were only one speaker in the center producing sound.

NOTE: The PHASE switches should be in their NORMAL position under normal circumstances. Also, when connecting speakers to the BA-90, be sure to connect the minus (–) side terminal of each speaker to the minus (–) side of each speaker terminal on the amplifier's rear. Do not make two speakers share the minus (–) side of one speaker terminal; doing so will deprive the PHASE switches of their function, and may also damage the power transistors. So be sure to connect each speaker to the corresponding speaker terminal separately.

CONNECTIONS

Connecting a Pre-amplifier (or Tuner)

Connect the left channel output of a pre-amplifier (or tuner) to the LEFT INPUT terminal, and the right channel output to RIGHT INPUT terminal on the amplifier's rear panel.

Connecting Speakers

Speakers with nominal impedance of 4 to 16 ohms may be hooked to this amplifier. Avoid using speakers with impedance below 4 ohms, for they may cause the protector circuit to operate at times.

Connect the (+) side of the left speaker with the (+) side of the LEFT speaker terminal, and the (-) side to the (-) side of the same speaker terminal on the rear of the amplifier. Then connect the (+) side of the right speaker to the (+) side of the RIGHT speaker terminal, and the (-) side to the (-) side of the same speaker terminal.

AC Outlets

Two AC outlets are provided on the amplifier's rear panel. The one marked SWITCHED is controlled by the POWER switch on the front and has a maximum capacity of 50VA, while the other marked UNSWITCHED is independent of the POWER switch and has a maximum capacity of 120VA. Never couple any appliance with a power requirement greater than these figures to these outlets; doing so is very dangerous and will very likely cause the amplifier to break down.

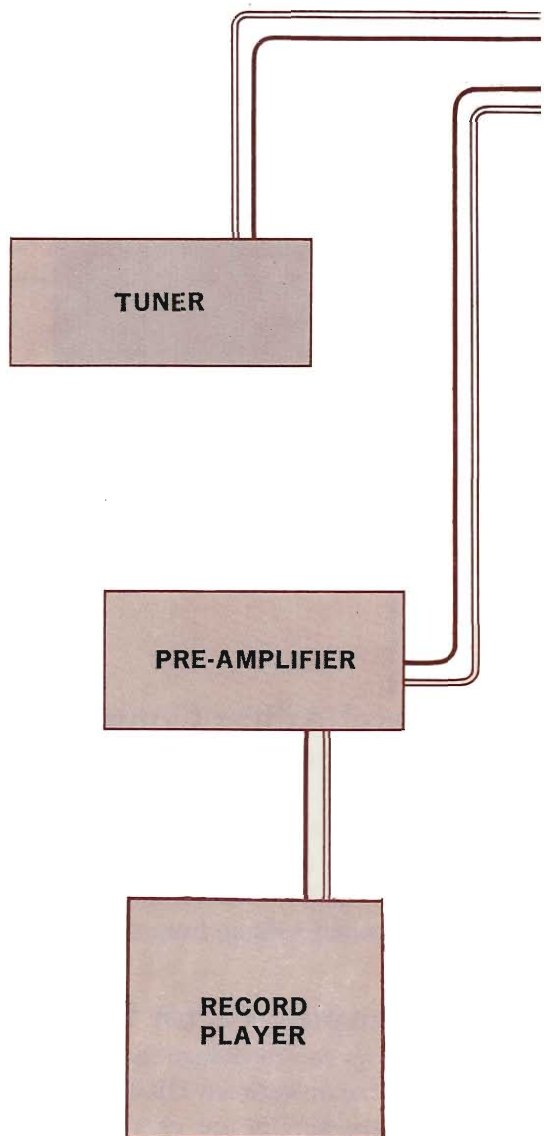

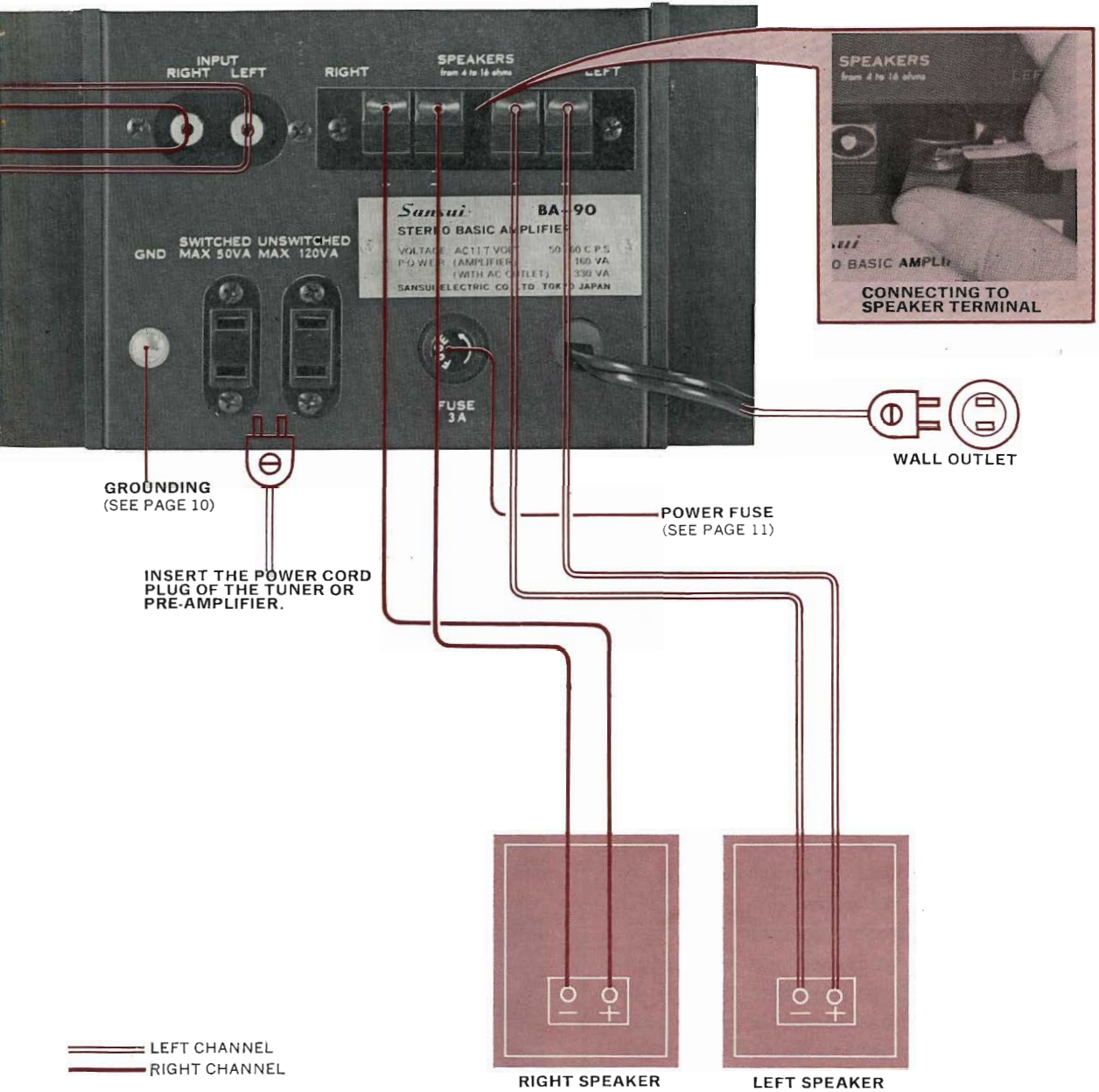

ELECTRONIC CROSSOVER SYSTEM

Frequencies audible to the human ear range from 20 to 20,000Hz. Therefore an ideal speaker is that which reproduces this entire frequency range with a flat response characteristic and without any distortion whatsoever. However, no single speaker currently available fulfills this requirement. The best present solution to this dilemma involves obtaining better reproduction characteristics through the use of a speaker with a superior response at low frequencies (woofer), one or more speakers with a superior response at middle frequencies (mid-ranges) and one or more speakers with a superior response at high frequencies (tweeters) to reproduce different sections (bands) of the audible frequency range.

The division of signals into these frequency bands can be achieved by placing an LC crossover network between the basic amplifier and speakers. Or it may be accomplished by a more advanced electronic crossover system, which requires an electronic crossover circuit to be placed behind the pre-amplifier, dividing its output into several (usually two or three) frequency bands for amplification and reproduction by separate basic amplifiers and speakers. At the present time, this latter system is considered by many people the best system for true high fidelity sound reproduction. Its advantages are many, as follow:

1) Speakers more freely selectable

Since the tweeter, midrange and woofer are driven by separate basic amplifiers, they can be freely selected on the virtue of their tone quality alone, without regard to their efficiency and impedance characteristics.

2) Intermodulation distortion reduced

Feeding low and high frequency signals together into one basic amplifier often causes intermodulation, increasing the distortion. With separate basic amplifiers amplifying different frequency bands, such possibility is practically eliminated.

3) Better filtering characteristic

Designing a perfect LC crossover network is a highly complex job, and even the best network may fail to offer a perfect filtering characteristic. Also, as the impedance of a speaker varies with frequency, a network does not always divide the signals at the predetermined crossover frequencies. In contrast, the electronic crossover system not only offers a much better filtering characteristic, but permits changing over the crossover frequencies and cutoff characteristics with great ease.

FULL-RANGE SPEAKER SYSTEM

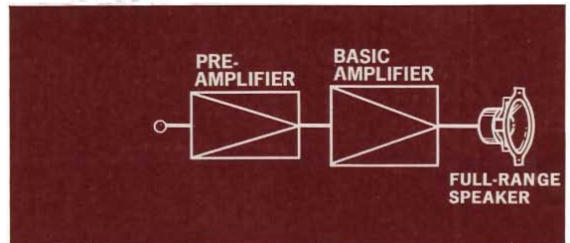

3 WAY CROSSOVER NETWORK SYSTEM

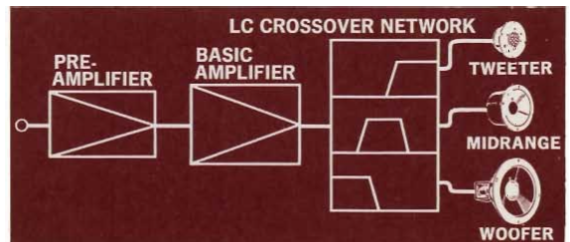

TRI-AMPLIFICATION ELECTRONIC CROSSOVER SYSTEM

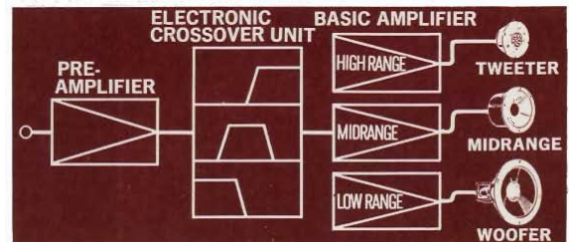

4) Amplifier's damping factor is not deteriorated with each basic amplifier coupled directly to a speaker, there is no resistance between these components to deteriorate the former's damping factor.

5) Basic amplifiers used more effectively
Amplifiers best suited for each frequency band may be used. For example, an amplifier with a fairly big output is suited for driving the woofer, while amplifiers with better tone quality characteristics may be employed for driving the midrange and tweeter.

The electronic crossover system offers a number of advantages as described above. Like everything else, however, it has a drawback, too. It is that it is more expensive to own, because it requires an electronic crossover unit and more than one basic amplifier.

If you wish to build an electronic crossover system using two or three BA-90's, bear these points in mind:

1) Be sure that the input impedance of the electronic crossover unit used is greater than the output impedance of the pre-amplifier. If the input impedance is the same or smaller

than the output impedance, it will cause distortion. Observe the same precaution with the output impedance of the electronic crossover unit and the input impedance of each basic amplifier used.

2) Be sure that the input voltage of the basic amplifier and the output voltages of the pre-amplifier and electronic crossover unit match each other. Also, use an electronic crossover unit having level adjust controls.

3) Make accurate level adjustment by using an oscillator or frequency record.

While the BA-90 is an ideal basic amplifier for use in an electronic crossover system, it may be used in conjunction with the SANSUI BA-60 basic amplifier, CD-5 electronic crossover unit, AU-777 and AU-555 control amplifiers. With these components, all the above precautions are already solved and a sophisticated electronic crossover system can be realized with surprising ease.

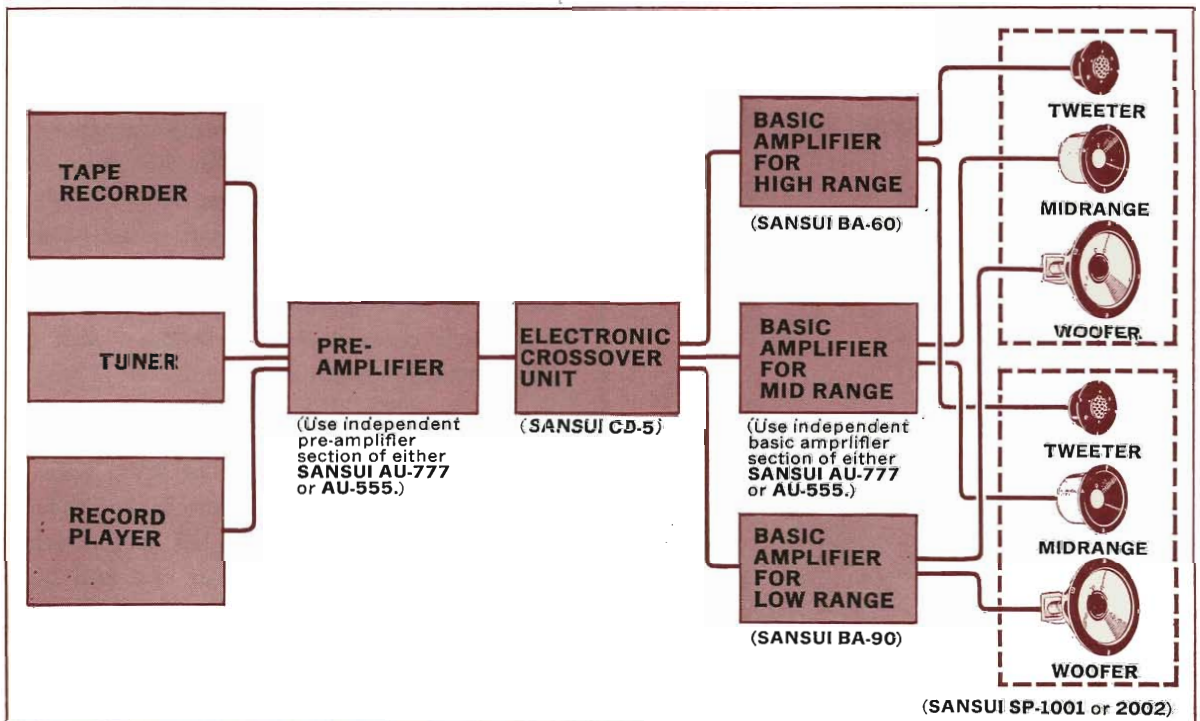

HINTS ON USE

Should the Quick Acting Fuses Blow...

In addition to the protector circuit described later, the BA-90 is provided with a pair of quick acting fuses to doubly protect the power transistors.

If no sound is heard from the speakers after the POWER switch is turned on and the POWER INDICATOR has lit up, it is either because the protector circuit has been activated or the quick acting fuses have blown. Turn off power immediately, wait about 5 seconds and turn on power again. If no sound is still heard from either or both speakers, check to see if the fuses have blown. To check, remove the power cord plug from the wall outlet and take off the amplifier's bonnet. If you find one or both fuses blown, replace them with the spare fuses (AGD 2A) supplied with the amplifier, after discovering and eliminating whatever trouble that caused them to blow.

If the new fuses should blow again after power is turned on, it is very likely that something has gone wrong with the output circuit. In this case, contact your nearest SANSUI dealer.

Connecting Input Sources

When connecting such input sources as a pre-amplifier and tuner, be sure to use thick shielded cable. Using parallel PVC wires (the kind often used for power line) usually results in increased hum. The length of the connection cable should not exceed 7 feet. The longer it is, the more the high frequency signals will be attenuated.

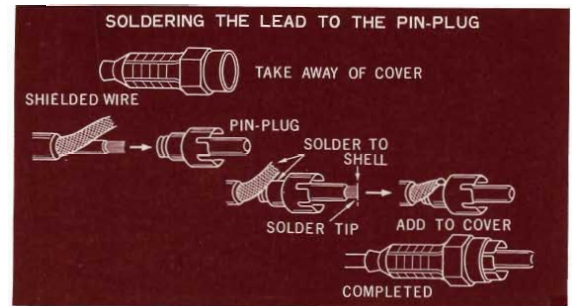

Make Proper Connections

Be sure that the connections between the lead wires of various input and output components and the respective input and output terminals are complete. If the lead wires are loose or in touch with other parts, the amplifier may not only fail to operate nominally, but noise may be induced. And the amplifier may even break down over a long period of time. Also, be sure that any component connected to the preamplifier, such as a phonograph and tape recorder, is properly connected in accordance with the manufacturer's instructions.

Grounding

Connect one end of a piece of PVC wire or enameled wire to the GND terminal on the left side of the amplifier's rear panel, then attach a small copper plate to the other end and bury it deep underground. Grounding the amplifier in this manner usually reduces noise. Also, if you are using the BA-90 in conjunction with a phonograph, tuner and tape recorder, connect

their grounding wires to the GND terminal. This will usually reduce hum to a great extent. **CAUTION:** Be sure that the power cord is removed from the wall AC outlet when making grounding connections.

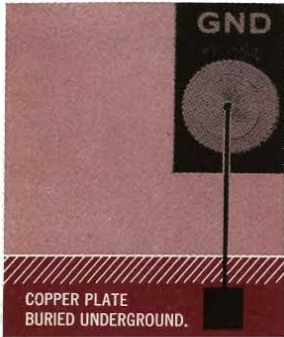

Heat Radiation

Transistors being relatively sensitive to heat, the BA-90 is designed so that any heat radiated will effectively escape through its bonnet. Therefore, placing something on top of the amplifier, encasing it in a tight cabinet or operating it in direct sunlight may lead to a breakdown. If any of these situations cannot be avoided, take special care to increase the amplifier's heat dissipation capability.

Should the Protector Operate...

While your BA-90's expensive silicon power transistors are sufficiently protected in circuit design, a protector circuit is also incorporated to protect them under all operating conditions. This circuit utilizes an SCR (silicon controlled rectifier). Should the output circuit be short-circuited for some reason or should excessively large inputs flow in from the input circuit and an overcurrent flood the power transistors, this circuit is activated to protect the all-important power transistors. No sound will then be heard from both or one of the speakers. There is also the possibility that the protector operates because of a momentary overcurrent.

Should the protector circuit operate, turn off power immediately. Wait about 5 seconds and turn on power again. If the amplifier should still fail to operate normally, it is more likely that the circuit has been activated because of a short-circuit in the output circuit. So check the speaker cords, speaker terminals and other parts of the output circuit for a short-circuit.

Should the Speaker Polarities Differ...

Should the right and left speakers be connected out of phase with each other (i.e., should they differ in polarity connections), reproduced sound will be weak in the center, with bass response particularly weakened. This condition will be very conspicuous when you play a monophonic record on a stereo phonograph, listen to an FM MONO broadcast or any music program on any broadcast band. To correct the wrong polarity connections, simply set either PHASE switch in its REVERSE position. Once the polarities are thus matched, the two speakers will sound as if there were only one speaker in the center producing sound.

HINTS ON USE

Voltage Change-over Plug

The BA-90 allows you to change over the working voltage of the primary side of its power supply circuit simply by shifting a plug among its four positions: 100V, 117V, 220V and 240V. The plug is usually set for the voltage in your area prior to shipment. But if you find it is different, reset the plug in the correct position. Simply insert the plug so that the arrow mark on it points at the correct voltage indication.

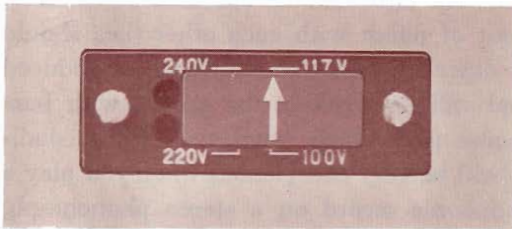

Should the Power Fuse Blow...

Should the amplifier fail to operate and you find it is because the power fuse has blown, remove the power cord from the wall outlet and then replace the blown fuse with a new glass-tubed 3-ampere fuse. Using a piece of wire or a fuse of a different capacity as a stop-gap measure is very dangerous and could lead to serious trouble. If you think the power fuse has blown because of trouble in the amplifier, discover and eliminate the trouble first before replacing it.



AC Outlets

Of the two AC outlets provided on the amplifier's rear panel, the one, marked SWITCHED,

is controlled by the POWER switch and is very convenient for powering a tuner. The marked UNSWITCHED, is independent of the POWER switch. They have a maximum capacity of 50 and 120VA, respectively. Coupling an appliance with a greater power requirement is very dangerous and may cause the amplifier to break down.



If Hum or Howling Noise is Heard When Playing a Record...

Hum or howling noise may be heard sometimes when playing a phonograph record or a recorded tape. More often than not, this is not due to a defective part in the amplifier itself, but happens for these reasons:

- 1) The phonograph is placed either directly on top of or near one of the speakers, and the acoustic vibration produced by the speaker is transmitted to the phonograph, causing howling. If this is the case, either move the phonograph away from the speakers, or place a thick cushion underneath the phonograph to absorb the vibration.
- 2) Hum may be produced because the phonograph or tape recorder (deck) is connected with something other than shielded cable. Or it may be produced because the shielding wire and core wire are connected inversely, the phonograph motor is not grounded, or the tonearm is not grounded completely. Check various connections carefully.

SPECIFICATIONS / CHARACTERISTICS

RATED POWER OUTPUT

MUSIC POWER (IHF): 90W (4 ohms)

70W (8 ohms)

CONTINUOUS POWER (left/right):

32/32W (4 ohms)

28/28W (8 ohms)

TOTAL HARMONIC DISTORTION:

Less than 0.3% at rated output

INTERMODULATION DISTORTION: (60Hz :

7,000Hz=4 : 1): Less than 0.3%

POWER BANDWIDTH(IHF): 15~40,000Hz (at 0.3% distortion)

FREQUENCY RESPONSE: 15~100,000Hz \pm 1dB
(8 ohms; at normal listening level)

INPUT SENSITIVITY (per 1,000 Hz input

required to deliver rated continuous output):

1V \pm 1dB at rated output

INPUT IMPEDANCE: More than 100k ohms

LOAD IMPEDANCE: 4~16 ohms

DAMPING FACTOR: 10 and over 50 (8 ohms)

HUM AND NOISE (IHF): Better than 80dB

CHANNEL SEPARATION: Better than 50dB

CIRCUIT COMPLEMENT: 17 transistors, 14 diodes,
1 SCR

POWER VOLTAGE: 100V, 117V, 220V, 240V
AC, 50/60Hz

POWER CONSUMPTION: 20VA (idling), 160VA
(at maximum output)

DIMENSIONS: 7 $\frac{1}{2}$ "W \times 14 $\frac{5}{16}$ "D \times 4 $\frac{3}{8}$ "H

WEIGHT: 16.5 lbs

* All rights reserve specifications subject to change without notice.

POWER BANDWIDTH CHARACTERISTIC

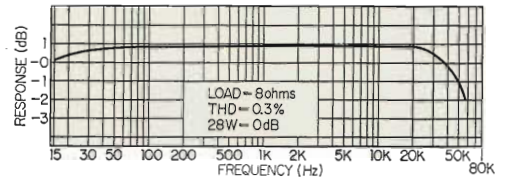

IM DISTORTION CHARACTERISTIC

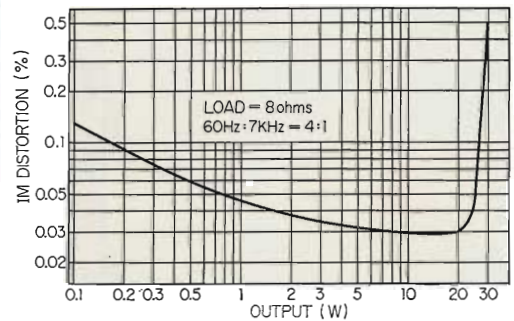

MUSIC POWER CHARACTERISTIC

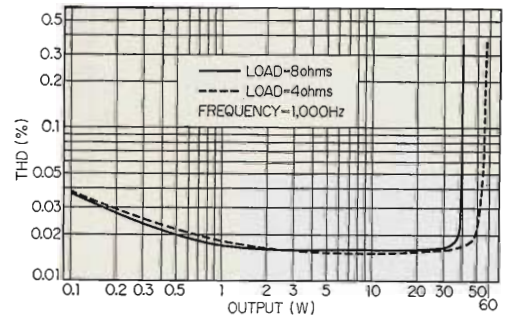

THD CHARACTERISTIC

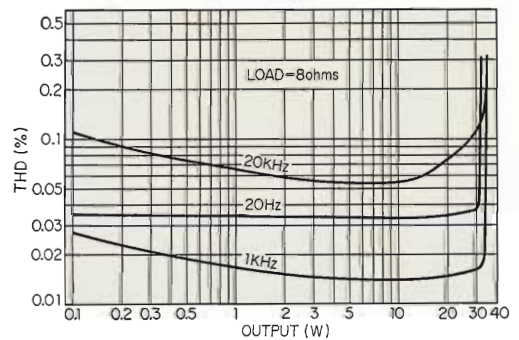

SCHEMATIC DIAGRAM

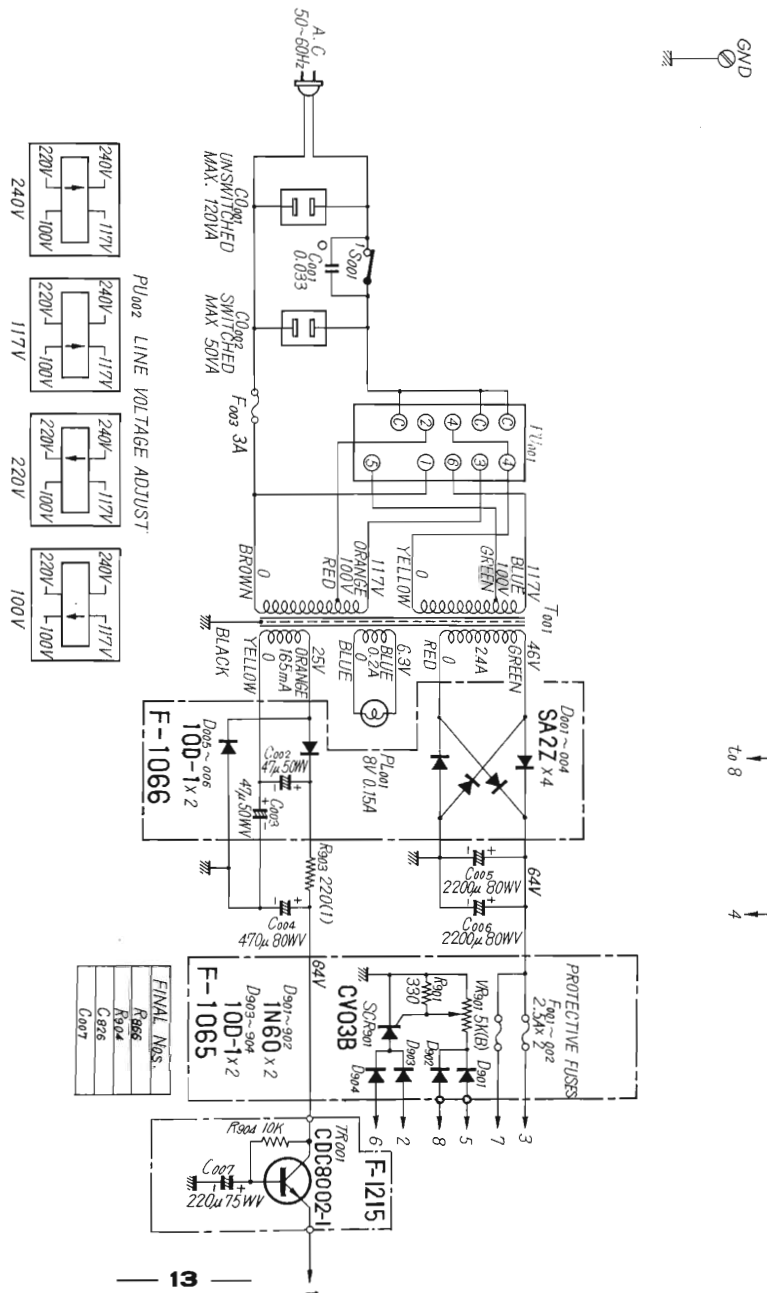

TRANSISTORS

- TR801 2SC871 or 2SC458LG
- TR802 2SC871 or 2SC458LG
- TR803 2N4250
- TR804 2N4250
- TR805 2SC7340 or Y
- TR806 2SC7340 or Y
- TR807 2SC826
- TR808 2SC826
- TR809 2SC708A
- TR810 2SC708A
- TR811 2SA537A
- TR812 2SA537A
- TR813 2SC889
- TR814 2SC889
- TR815 2SC889
- TR816 2SC889
- TR801 CDC8002-1

SWITCHES

- SR801-6 DAMPING FACTOR
 - 1 HIGH
 - 2 LOW
- SR82-6 AURAL NULL BALANCE
 - 1 NORMAL
 - 2 TEST
- SR83 PHASE
 - 1 NORMAL
 - 2 REVERSE
- SR84 PHASE
 - 1 NORMAL
 - 2 REVERSE
- SR81 POWER
 - 1 ON
 - 2 OFF

VARIABLE RESISTORS

- VR801 LEVEL ADJUST
- VR802 LEVEL ADJUST
- VR803 ALTERNATING CURRENT ADJUST
- VR804 ALTERNATING CURRENT ADJUST
- VR805 DIRECT CURRENT ADJUST
- VR806 DIRECT CURRENT ADJUST
- VR801 PROTECTOR LEVEL ADJUST

- ⊗ MYLAR CAPACITORS
- MICA CAPACITORS
- OIL CAPACITORS

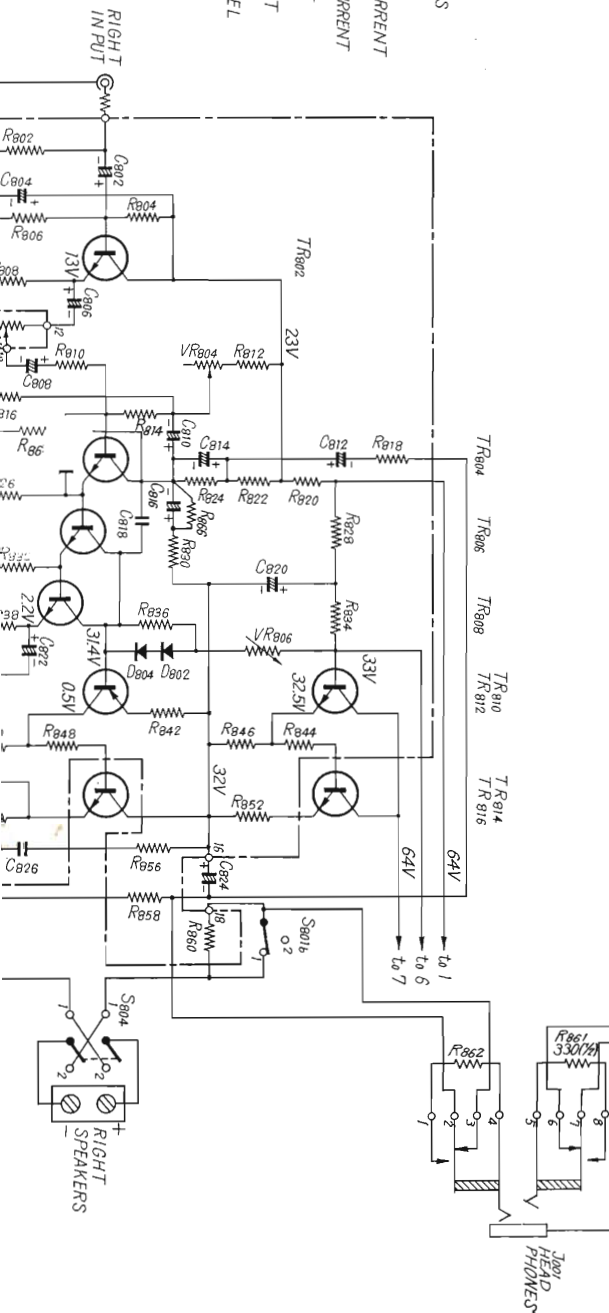
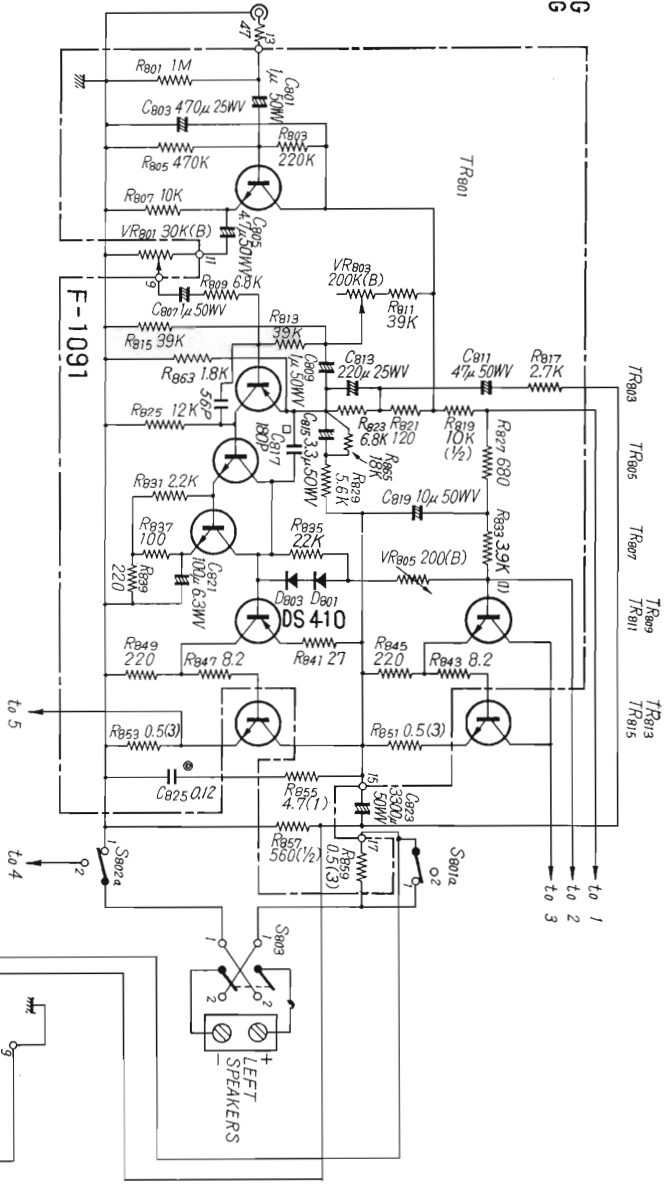

TROUBLESHOOTING CHART

A Quick Check List

- 1) **Connections:** Are other components properly connected to the amplifier? Is the amplifier properly plugged into the wall AC outlet?
- 2) **Operation:** Are you operating the amplifier correctly as instructed in this booklet?
- 3) **Installation:** Is the amplifier properly positioned in relation to the speakers and phono-

graph?

4) **Defective components:** Are the audio components connected to the amplifier defective?

5) **Performance characteristic:** Are you not placing an excessive strain on the amplifier to raise some particular performance characteristic?

PROGRAM	SYMPTOM	PROBABLE CAUSE	REMEDY
Radio broadcast	Constant or intermittent noise heard at certain hours or in a certain area.	Electric discharge or oscillation by a fluorescent lamp, TV, series motor, electrical contact, rectifier, oscillator, etc. Insufficient antenna input due to long distance from broadcast stations or obstruction of signals by mountains or high ferro-concrete buildings. Interference by other radio waves. Natural phenomena such as an atmospheric discharge and lightning.	Attach a noise suppressor to the tuner or the electrical appliance producing the noise. Place the tuner away from the electrical appliance producing the noise. Install an outdoor antenna and ground the amplifier to improve its S/N ratio. If the noise occurs at a certain frequency, attach a wave trap to the antenna input circuit of the tuner. Reverse the inserted position of the power cord plug.
	Noise heard on AM band at certain hours, in a certain area or at particular broadcast frequencies.	Insufficient signal strength.	Install an outdoor AM antenna, or if it is already installed, re-position it for best reception. Ground the amplifier and/or reverse the inserted position of the power cord plug.
	High-frequency noise.	Interference by adjacent channel (beat interference). TV set near to the amplifier is in use.	While noise due to such causes cannot be eliminated by adjusting the amplifier, it can be made less disturbing by turning down the TREBLE tone control or turning on the HIGH FILTER switch on the preamplifier. Move the amplifiers away from the TV set.
	FM broadcast reception is noisy.	Poor noise limiter effect and lowered SN ratio due to insufficient antenna input, resulting either from poorly positioned FM antenna or long distance from stations.	Re-position the FM antenna from the least noise and best reception. If this proves ineffective, install an exclusive outdoor FM antenna and position it for the best reception.

PROGRAM	SYMPTOM	PROBABLE CAUSE	REMEDY
Radio broadcast (cont'd)	NOTE: Quality of FM broadcast reception is largely affected by the transmitting conditions (such as antenna efficiency) of broadcast stations. So you may receive one station quite well while having difficulty in receiving another.		TV antenna may be shared for FM broadcast reception, but be sure to use a divider and make certain the TV reception is not affected. Excessively long antenna may increase noise.
	Scratchy noise on FM band.	Ignition noise made by the starting of a nearby automobile engine (particularly loud near 15MHz on dial scale).	No effective remedy except to move the antenna as far away from the street as possible or increase the antenna input as instructed above. Position the antenna so as to maximize the antenna input.
	Noise heard with FM MPX broadcasts that was not heard with FM monophonic broadcasts.	Unavoidable because of the nature of FM MPX signals which cut down effective service area to half that of FM monophonic signals	Turning on HIGH FILTER switch and/or turning down TREBLE tone control may considerably reduce the noise.
Record and tape	Hum or howling.	Phonograph is placed on top of or near one of the speakers. Use of wire other than shielded wire. Incomplete connection. Connection cord too close to power cord and/or electrical appliances such as a fluorescent lamp. Existence of an amateur radio station or TV transmitting antenna in the vicinity.	Place a cushion underneath the phonograph. Try changing the location of the phonograph and speakers. Use regular shielded wire to make interconnections. Turning on LOW FILTER switch may help. Minimize the length of connection cord. Refrain from turning up BASS tone control too high. Consult your nearest governmental (or municipal) radio regulatory office.
	Surface noise.	Worn or damaged record, or dust on record. Worn stylus, or dust on stylus. Improper stylus pressure.	Turning down TREBLE tone control or turning on HIGH FILTER switch may help. Recondition (or replace) the phonograph stylus or tape head.
All programs	BALANCE control is off the center position when sound volumes in the right and left channels are balanced.	Position of the BALANCE control which gives equal sound volume from both channels varies from program to program.	Set the pre-amplifier's MODE switch in MONO and adjust its BALANCE control for equal sound volume from both channels. Or make more precise adjustment using the AURAL NULL BALANCE switch on this amplifier. Check if the efficiency of one speaker is balanced with that of the other.

ALIGNMENT

TEST POINT

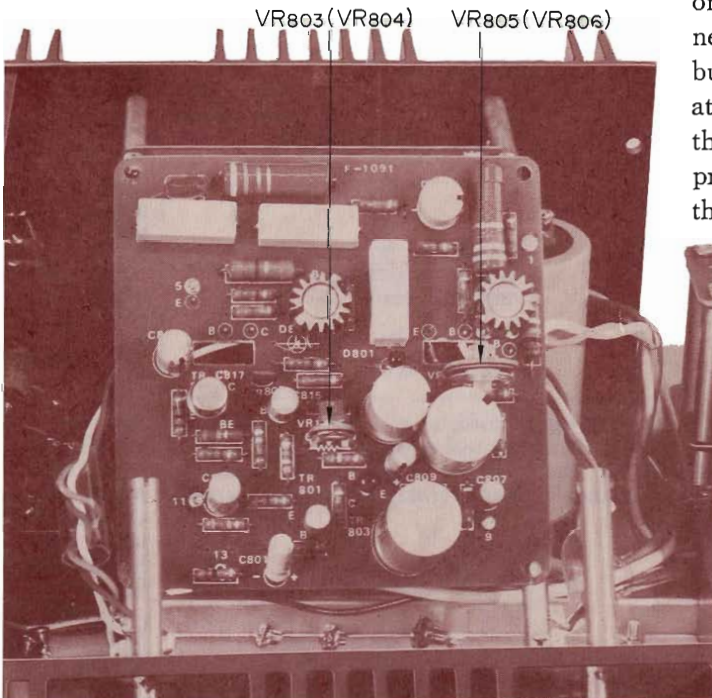
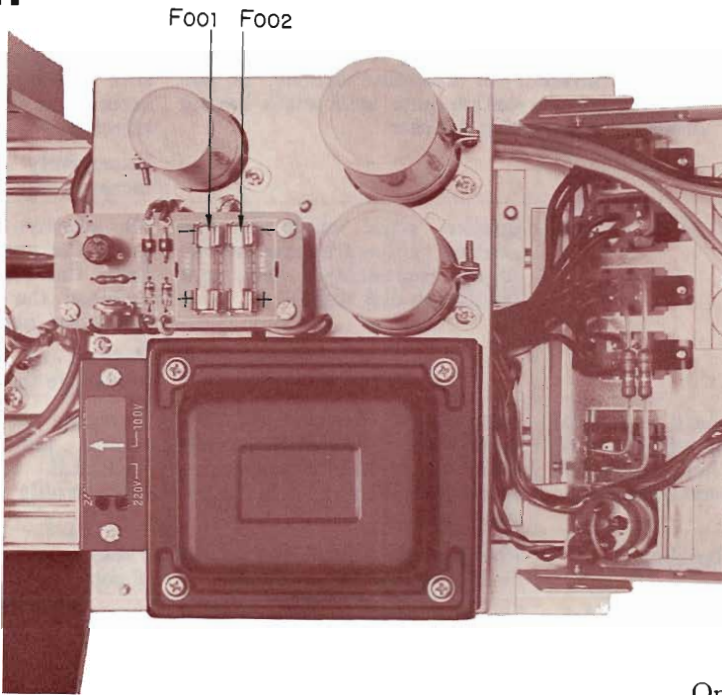

Only the test points for one of the stereo channels are indicated here, but test points also exist at the same positions on the corresponding printed circuit sheet for the other channel.

OUTPUT ADJUSTMENT

STEP	CONNECT/ADJUST	REMARKS
1.	Turn left (right) LEVEL ADJUST control down to "O".	
2.	Turn bias current adjustment variable resistor VR ₈₀₅ (VR ₈₀₆) fully counterclockwise. Set AURAL NULL BALANCE switch and PHASE switches to "NORMAL".	
3.	Set oscillator at 1,000Hz and connect it to left (right) channel INPUT terminal.	Use audio oscillator with oscillating frequency range of 20 to 20,000Hz and output voltage of 1V or more.
4.	Connect 8 or 16 ohms resistor with capacity of more than 50W to left (right) speaker terminal.	
5.	Connect oscilloscope to speaker terminal.	
6.	Turn on POWER switch, raise volume slowly and confirm on oscilloscope that there is output at speaker terminal.	
7.	Adjust VR ₈₀₃ (VR ₈₀₄) so that both peaks of output waveform—sine wave—will be clipped simultaneously.	
8.	Repeat the above process for the right channel. Parentheses indicate what to be adjusted for the right channel.	

CAUTION: Be sure to turn bias current adjustment variable resistors VR₈₀₅ and VR₈₀₆ fully counterclockwise **before** setting out to make output adjustment. Failure to do so may damage the power transistors.

CURRENT ADJUSTMENT

STEP	AMMETER (TESTER)	CONNECT/ADJUST	REMARKS
1.		Remove F ₀₀₁ and F ₀₀₂ .	Use ammeter with a 500mA or 50mA range.
2.		Turn variable resistors VR ₈₀₅ and VR ₈₀₆ fully counterclockwise.	
3.		Turn on POWER switch	
4.	Set in 500mA range.	Connect ammeter where F ₀₀₁ was before (connect ammeter's (-) terminal to "3" on schematic diagram and (+) terminal to the other).	Be sure to turn on POWER switch before connecting ammeter.
5.	Set in 100mA or 50mA range.	Adjust VR ₈₀₅ so that ammeter will indicate 25 to 30mA if room temperature is below 25°C, and 20 to 25mA if it is over 25°C.	
6.	Set in 500mA range.	Turn off POWER switch and replace F ₀₀₁ . Turn on POWER switch again, and connect ammeter where F ₀₀₂ was before (connect ammeter's (-) terminal to "7" on schematic diagram and (+) terminal to the other).	Be sure to turn on POWER switch before connecting ammeter.
7.	Set in 100mA or 50mA range.	Adjust VR ₈₀₆ so that ammeter will indicate 25 to 30mA if room temperature is below 25°C, and 20 to 25mA if it is over 25°C.	

CAUTION: Be sure to make output adjustment **before** making current adjustment. If this order is reversed, not only does it become impossible to make accurate current adjustment, but the power transistors may be damaged.

PRINTED CIRCUIT SHEETS AND PARTS LIST

X: Parts No Y: Parts Name Z: Position of Parts

PROTECTOR BLOCK <F-1065>

X	Y	Z
R901	330Ω ±10% ¼W Carbon Resistor	2 A
D901	IN60 Germanium Diode (031033)	2 A
D902	IN60 Germanium Diode (031033)	2 A
D903	10D-1 Silicon Diode (031034)	1 A
D904	10D-1 Silicon Diode (031034)	1 A
SCR901	CV03B Silicon SCR (035004)	1 A
VR901	5kΩ (B) Protector Adjustor (103040)	2 A
F001	2.5A Fuse (043009)	1 B, 2 B
F002	2.5A Fuse (043009)	1 B, 2 B

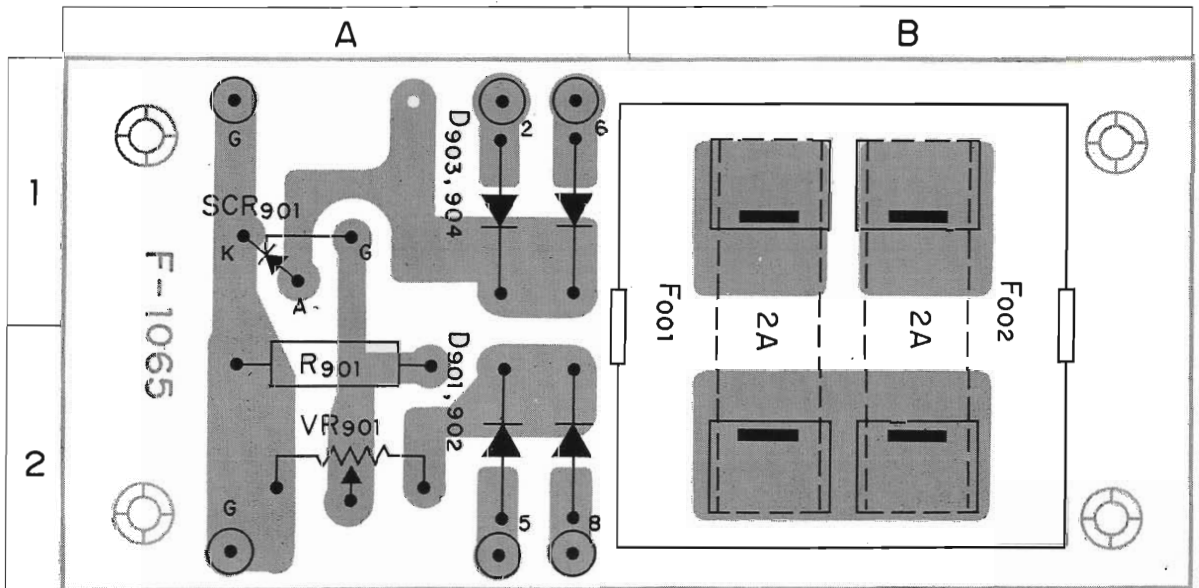

POWER BLOCK <F-1066>

X	Y	Z
C002	47 μ F 50WV Electrolytic Capacitor	1 A
C003	47 μ F 50WV Electrolytic Capacitor	2 A
D001	SA-2Z Silicon Diode (031042)	1 B
D002	SA-2Z Silicon Diode (031042)	1 B
D003	SA-2Z Silicon Diode (031042)	2 B
D004	SA-2Z Silicon Diode (031042)	2 B
D005	10D-1 Silicon Diode (031034)	1 A
D006	10D-1 Silicon Diode (031034)	2 A

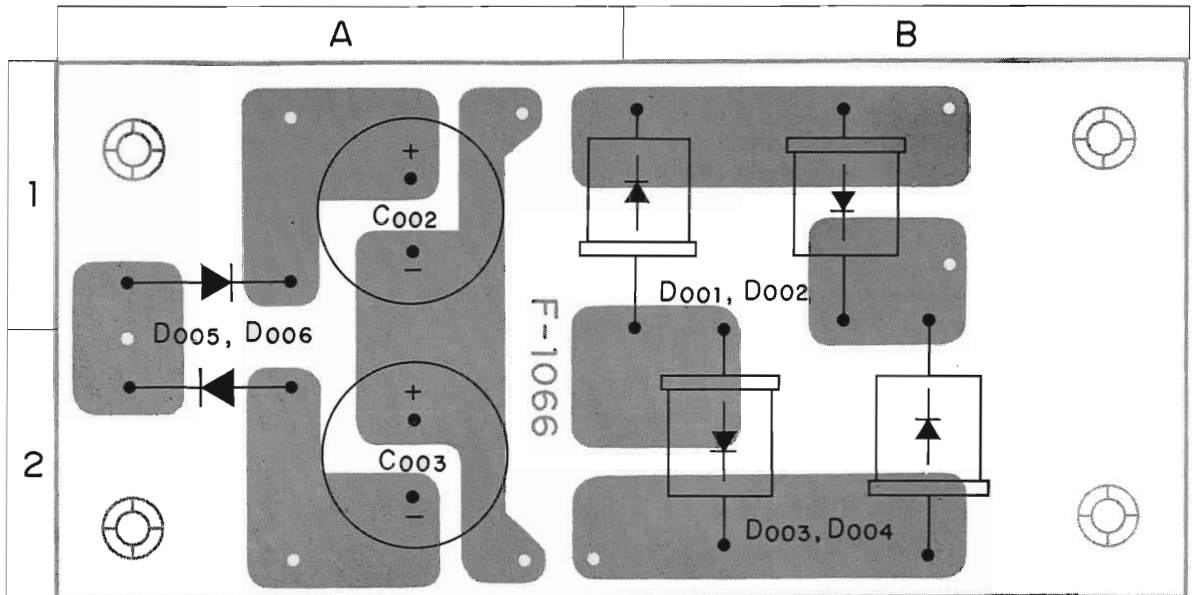

PRINTED CIRCUIT SHEETS AND PARTS LIST

X: Parts No Y: Parts Name Z: Position of Parts

DRIVER AMP. BLOCK <F-1090>

X	Y	Z
R802	1M Ω \pm 10% $\frac{1}{4}$ W Carbon Resistor	2 B
R804	220k Ω \pm 10% $\frac{1}{4}$ W Carbon Resistor	2 B
R806	470k Ω \pm 10% $\frac{1}{4}$ W Carbon Resistor	2 B
R808	10k Ω \pm 10% $\frac{1}{4}$ W Carbon Resistor	2 B
R810	6.8k Ω \pm 10% $\frac{1}{4}$ W Carbon Resistor	2 A
R812	39k Ω \pm 10% $\frac{1}{4}$ W Carbon Resistor	2 A
R814	39k Ω \pm 10% $\frac{1}{4}$ W Carbon Resistor	2 A
R816	39k Ω \pm 10% $\frac{1}{4}$ W Carbon Resistor	2 B
R818	2.7k Ω \pm 10% $\frac{1}{4}$ W Carbon Resistor	1 A
R820	10k Ω \pm 10% $\frac{1}{2}$ W Carbon Resistor	1 A
R822	120 Ω \pm 10% $\frac{1}{4}$ W Carbon Resistor	2 A
R824	6.8k Ω \pm 10% $\frac{1}{4}$ W Carbon Resistor	2 A
R826	12k Ω \pm 10% $\frac{1}{4}$ W Carbon Resistor	2 B
R828	680 Ω \pm 10% $\frac{1}{4}$ W Carbon Resistor	1 A
R830	5.6k Ω \pm 10% $\frac{1}{4}$ W Carbon Resistor	2 B
R832	2.2k Ω \pm 10% $\frac{1}{4}$ W Carbon Resistor	2 B
R834	3.9k Ω \pm 10% 1 W Carbon Resistor	1 A
R836	2.2k Ω \pm 10% $\frac{1}{4}$ W Carbon Resistor	1 B
R838	100 Ω \pm 10% $\frac{1}{4}$ W Carbon Resistor	2 B
R840	220 Ω \pm 10% $\frac{1}{4}$ W Carbon Resistor	2 B
R842	27 Ω \pm 10% $\frac{1}{4}$ W Carbon Resistor	1 A
R844	8.2 Ω \pm 10% $\frac{1}{4}$ W Carbon Resistor	1 A
R846	220 Ω \pm 10% $\frac{1}{4}$ W Carbon Resistor	1 A
R848	8.2 Ω \pm 10% $\frac{1}{4}$ W Carbon Resistor	1 B
R850	220 Ω \pm 10% $\frac{1}{4}$ W Carbon Resistor	1 B
R852	0.5 Ω \pm 20% 3 W Wire-Wound Resistor (012030)	1 A
R854	0.5 Ω \pm 20% 3 W Wire-Wound Resistor (012030)	1 B
R856	4.7 Ω \pm 10% 1 W Carbon Resistor	1 B
R858	560 Ω \pm 10% $\frac{1}{2}$ W Carbon Resistor	1 B
R860	0.5 Ω \pm 20% 3 W Wire-Wound Resistor (012030)	2 B
R864	1.8k Ω \pm 10% $\frac{1}{4}$ W Carbon Resistor	2 A
R866	18k Ω \pm 10% $\frac{1}{4}$ W Carbon Resistor	2 B
C802	1 μ F 50WV Electrolytic Capacitor	2 B
C804	470 μ F 25WV Electrolytic Capacitor	2 A
C806	4.7 μ F 50WV Electrolytic Capacitor	2 B
C808	1 μ F 50WV Electrolytic Capacitor	2 A
C810	1 μ F 50WV Electrolytic Capacitor	2 A
C812	47 μ F 50WV Electrolytic Capacitor	2 A
C814	220 μ F 25WV Electrolytic Capacitor	2 A
C816	3.3 μ F 50WV Electrolytic Capacitor	2 B
C818	180 pF \pm 10% 50WV Mica Capacitor	2 B
C820	10 μ F 50WV Electrolytic Capacitor	1 A
C822	100 μ F 6.3WV Electrolytic Capacitor	1 B
C826	0.12 μ F \pm 10% 50WV Mylar Capacitor	1 B

X	Y	Z
D802	DS410 Variable Resistor (031046)	1 A
D804	DS410 Variable Resistor (031046)	1 B
TR802	Silicon Transistor 2SC871 E, F, 2SC458LG B or C (030547-1,-2, 030531 or-1)	2 B
TR804	2N4250 Silicon Transistor (030316)	2 A
TR806	2SC734 Silicon Transistor (030536 020536-1)	2 B
TR808	2SC826 Silicon Transistor (030528)	2 B
TR810	2SC708A Silicon Transistor (030548-1 030548-2)	1 A
TR812	2SA537A Silicon Transistor (030012-1 030012-2)	1 B
VR804	200k Ω (B) AC Balance Adjustor (103008)	2 B
VR806	200 Ω (B) DC Balance Adjustor (103012)	2 A

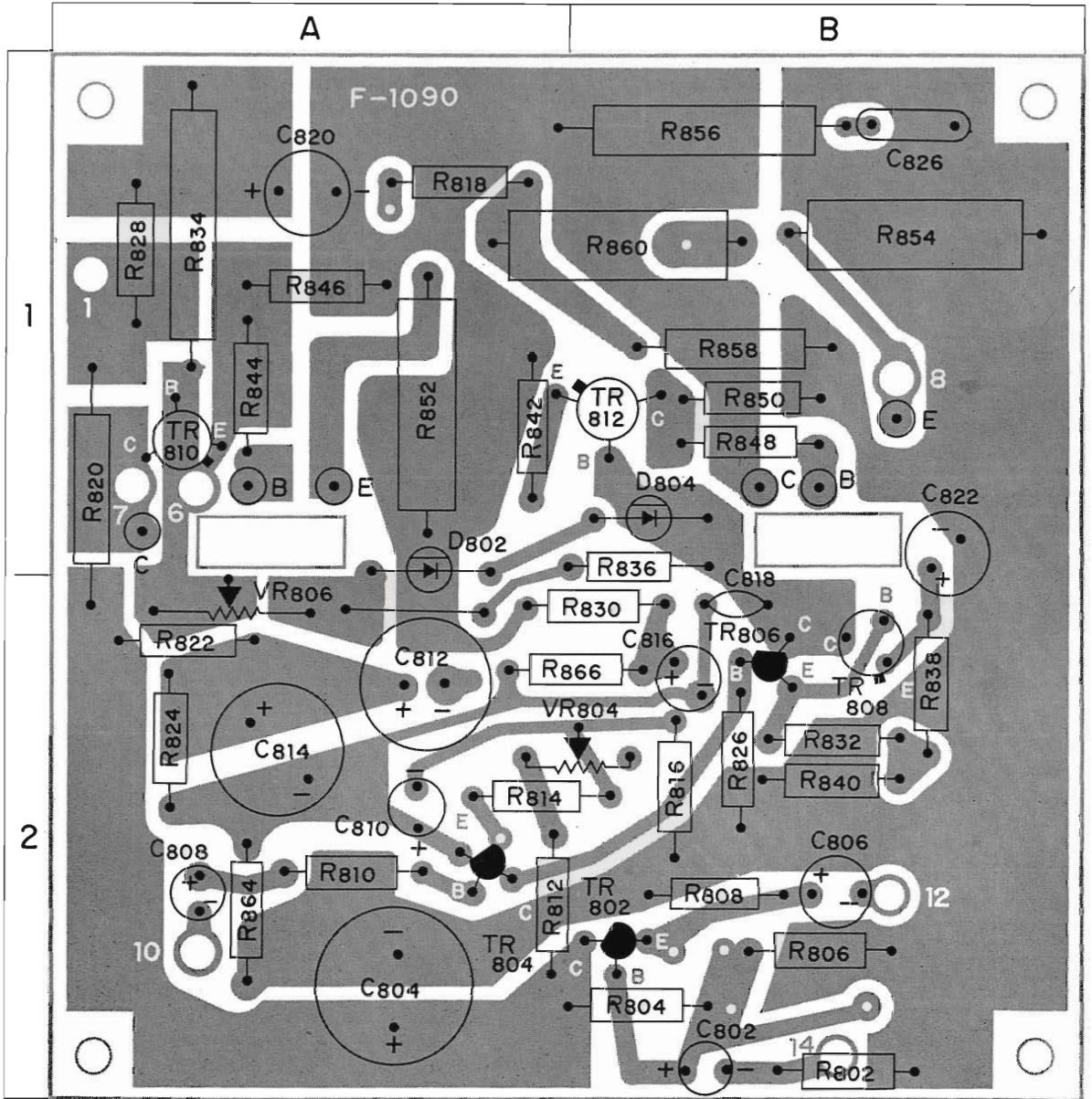

PRINTED CIRCUIT SHEETS AND PARTS LIST

X: Parts No Y: Parts Name Z: Position of Parts

DRIVER AMP. BLOCK <F-1091>

X	Y	Z
R801	1M Ω \pm 10% 1/4W Carbon Resistor	2 A
R803	220k Ω \pm 10% 1/4W Carbon Resistor	2 A
R805	470k Ω \pm 10% 1/4W Carbon Resistor	2 A
R807	10k Ω \pm 10% 1/4W Carbon Resistor	2 A
R809	6.8k Ω \pm 10% 1/4W Carbon Resistor	2 B
R811	39k Ω \pm 10% 1/4W Carbon Resistor	2 B
R813	39k Ω \pm 10% 1/4W Carbon Resistor	2 B
R815	39k Ω \pm 10% 1/4W Carbon Resistor	2 A
R817	2.7k Ω \pm 10% 1/2W Carbon Resistor	1 B
R819	10k Ω \pm 10% 1/2W Carbon Resistor	1 B
R821	120 Ω \pm 10% 1/4W Carbon Resistor	2 B
R823	6.8k Ω \pm 10% 1/4W Carbon Resistor	2 B
R825	12k Ω \pm 10% 1/4W Carbon Resistor	2 A
R827	680 Ω \pm 10% 1/4W Carbon Resistor	1 B
R829	5.6k Ω \pm 10% 1/4W Carbon Resistor	2 A
R831	2.2k Ω \pm 10% 1/4W Carbon Resistor	2 A
R833	3.9k Ω \pm 10% 1W Carbon Resistor	1 B
R835	2.2k Ω \pm 10% 1/4W Carbon Resistor	1 A
R837	100 Ω \pm 10% 1/4W Carbon Resistor	2 A
R839	220 Ω \pm 10% 1/4W Carbon Resistor	2 A
R841	27 Ω \pm 10% 1/4W Carbon Resistor	1 B
R843	8.2 Ω \pm 10% 1/4W Carbon Resistor	1 B
R845	220 Ω \pm 10% 1/4W Carbon Resistor	1 B
R847	8.2 Ω \pm 10% 1/4W Carbon Resistor	1 A
R849	220 Ω \pm 10% 1/4W Carbon Resistor	1 A
R851	0.5 Ω \pm 20% 3W Wire-Wound Resistor (012030)	1 B
R853	0.5 Ω \pm 20% 3W Wire-Wound Resistor (012030)	1 A
R855	4.7 Ω \pm 10% 1W Carbon Resistor	1 A
R857	560 Ω \pm 10% 1/2W Carbon Resistor	1 A
R859	0.5 Ω \pm 20% 3W Wire-Wound Resistor (012030)	1 A
R863	1.8k Ω \pm 10% 1/4W Carbon Resistor	2 B
R865	18k Ω \pm 10% 1/4W Carbon Resistor	2 A
C801	1 μ F 50WV Electrolytic Capacitor	2 A
C803	470 μ F 25WV Electrolytic Capacitor	2 B
C805	4.7 μ F 50WV Electrolytic Capacitor	2 A
C807	1 μ F 50WV Electrolytic Capacitor	2 B
C809	1 μ F 50WV Electrolytic Capacitor	2 B
C811	47 μ F 50WV Electrolytic Capacitor	2 B
C813	220 μ F 25WV Electrolytic Capacitor	2 B
C815	3.3 μ F 50WV Electrolytic Capacitor	2 A
C817	180pF \pm 10% 50WV Mica Capacitor	2 A
C819	10 μ F 50WV Electrolytic Capacitor	1 B
C821	100 μ F 6.3WV Electrolytic Capacitor	1 A
C825	0.12 μ F \pm 10% 50WV Mylar Capacitor	1 A

X	Y	Z
D801	DS410 Variable Resistor (031046)	1 B
D803	DS410 Variable Resistor (031046)	1 A
TR801	Silicon Transistor 2SC871 E, F, 2SC458 LG B or C (030547-1,-2, 030531 or-1)	2 A
TR803	2N4250 Silicon Transistor (030316)	2 B
TR805	2SC734 Silicon Transistor (030536 030536-1)	2 A
TR807	2SC826 Silicon Transistor (030528)	2 A
TR809	2SC708A Silicon Transistor (030548-1 030548-2)	1 B
TR811	2SA537A Silicon Transistor (030012-1 030012-2)	1 A
VR803	200k Ω (B) AC Balance Adjustor (103008)	2 A
VR805	200 Ω (B) DC Balance Adjustor (103012)	2 B

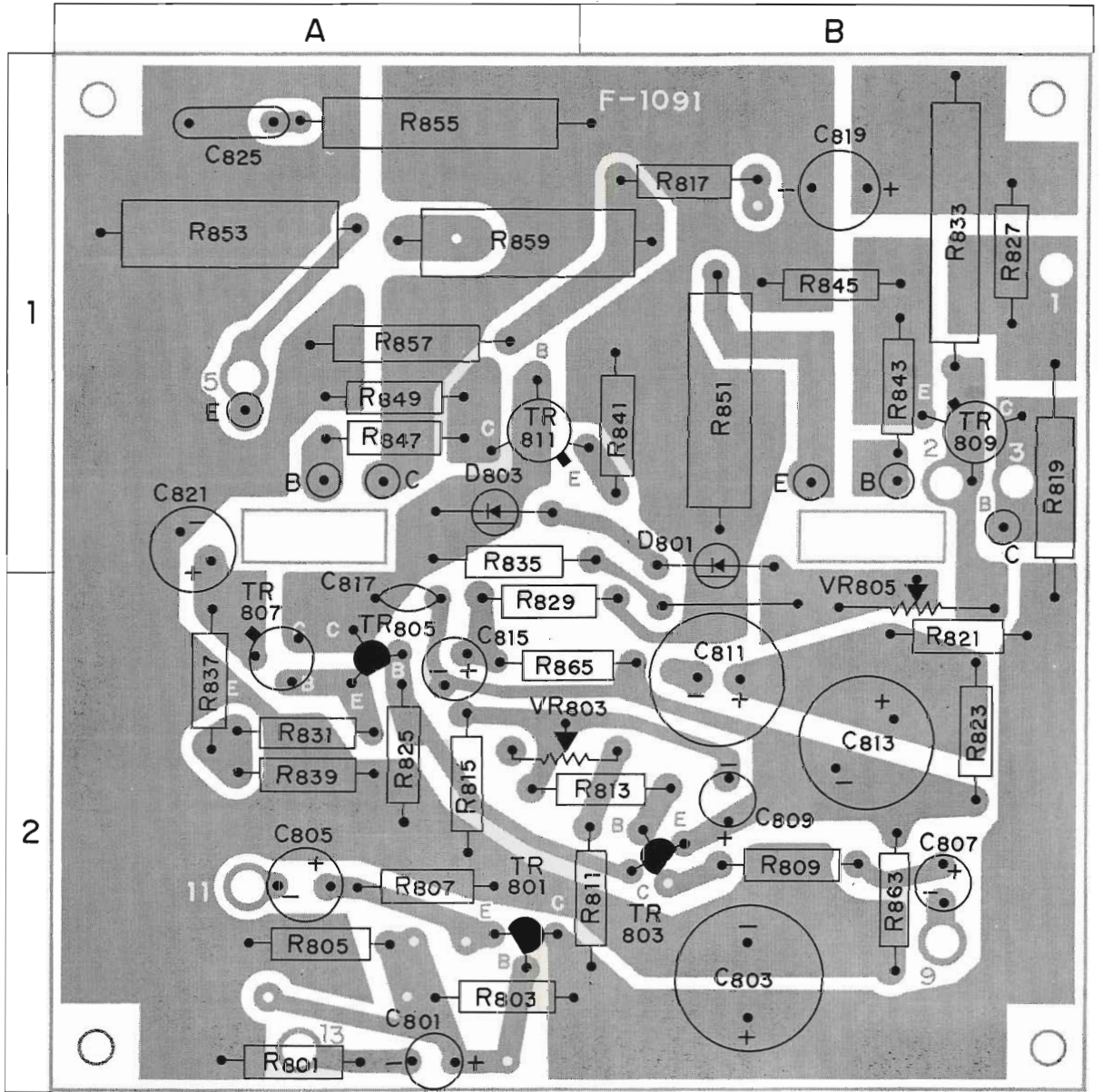

OTHER PARTS AND THEIR POSITION ON CHASSIS

X: Parts No Y: Parts Name

X	Y	
R861	330Ω ±10% ½W	Carbon Resistor
R862	330Ω ±10% ½W	Carbon Resistor
R903	220Ω ±10% 1 W	Carbon Resistor
R904	10kΩ ±10% ¼W	Carbon Resistor
C823	3300μF 50 WV	Electrolytic Block Capacitor (020544)
C824	3300μF 50 WV	Electrolytic Block Capacitor (020544)
C001	0.033μF 600 WV	Oil Capacitor
C004	470μF 80 WV	Electrolytic Block Capacitor (020545)
C005	2200μF 80 WV	Electrolytic Block Capacitor (020543)
C006	2200μF 80 WV	Electrolytic Block Capacitor (020543)
C007	220μF 75 WV	Electrolytic Capacitor
VR801	30kΩ(B) Level Adjustor	(100019)
VR802	30kΩ(B) Level Adjustor	(100019)
TR001	CDC8002-1 Silicon Transistor	(030555)
T001	Power Transformer	(400038)
F003	Fuse Holder	(230002)
F003	3A Fuse	(043004)
PL001	Pilot Socket	(232007)
PL001	8V 0.15A Pilot Lamp	(040012)
J001	Headphones Jack	(243006)
C001	AC Outlet	(245001-1)
C002	AC Outlet	(245001-1)
PU001	Voltage Selector Socket	(241008)
PU002	Voltage Selector Plug	(241009)
S801	Damping Factor Switch	(117009)
S802	Aural Null Balance Switch	(117009)
S803	Phase Switch	(117009)
S804	Phase Switch	(117009)
S001	Power Switch	(113009)

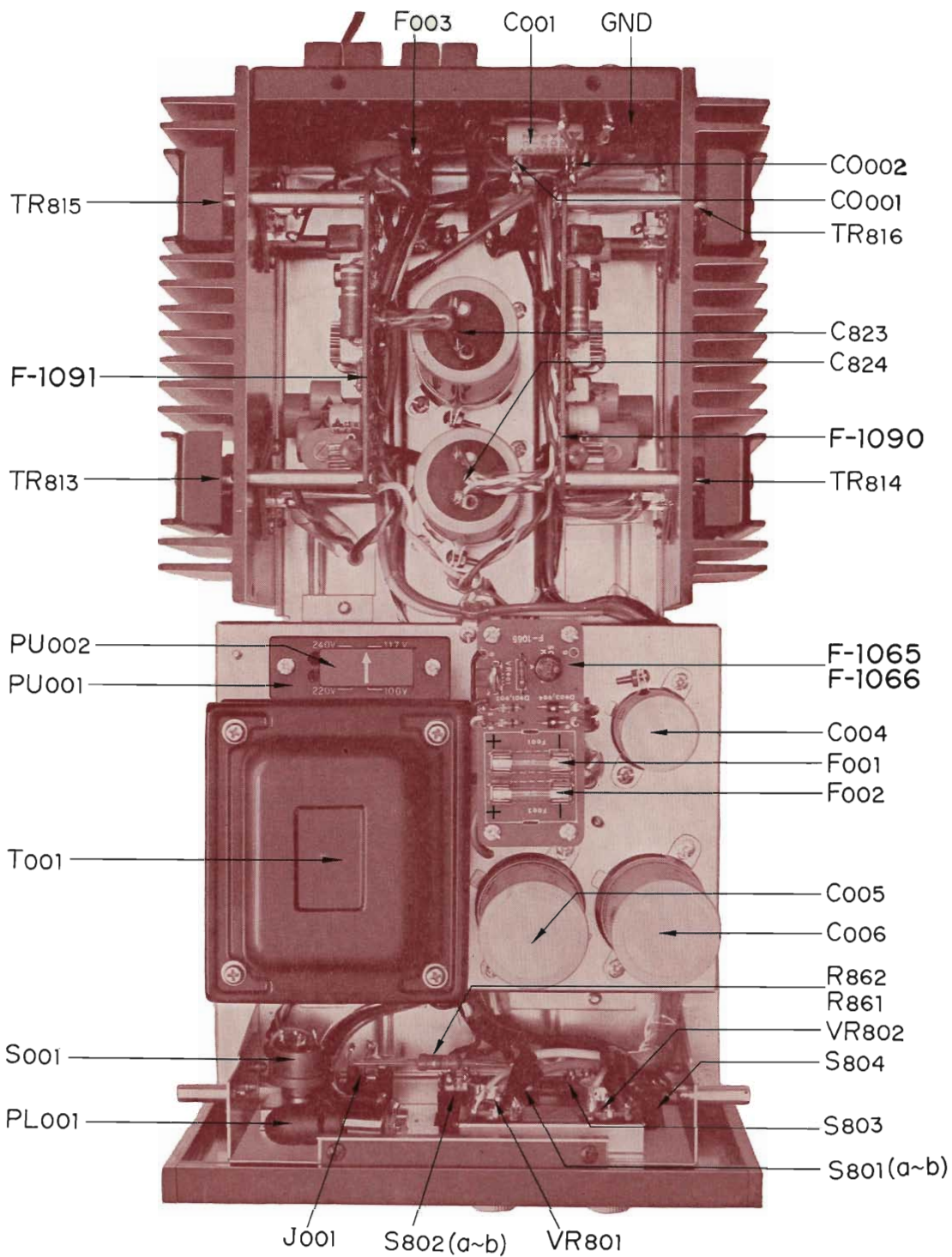



Sansui[®]



SANSUI ELECTRIC COMPANY LIMITED



Head Office; 14-1, 2-chome, Izumi, Suginami-ku, Tokyo, Japan. TEL. 323-1111

Printed in Japan (79010M)

SCHEMATIC DIAGRAM

